

vCam-6 Quick Guide V1.5



What's in the box:

- SD card
- USB thumb drive
- 12V DC power cord
- AC power cord
- Camera removal tool
- Flat screwdriver
- CD with user handbook & codecs
- Carry pouch

Refer to the user manual for detailed instructions, safety and care information.



Fuse - Make sure the 10A-250V fuse is installed in the fuse compartment on the back of the unit.



Do not use pressure washers to clean the reel, pushrod, spring assembly or camera heads. Use low-pressure water to rinse off the reel components.



Control Module Interface

Media Ports (left side)

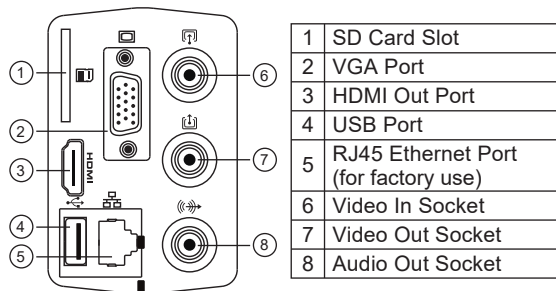

Main Controls (front panel)

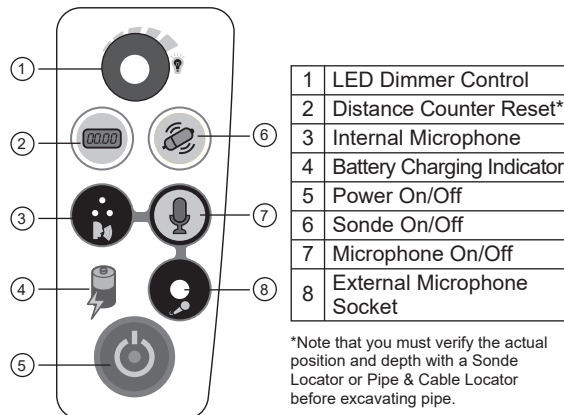

Video Recording/Playback Controls

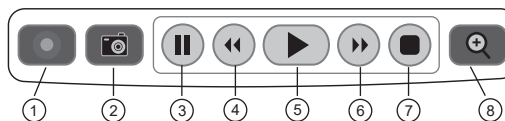

1	Start / Stop Video Recording
2	JPEG Snapshot Capture
3	Pause Video Recording or Playback
4	Rewind Video Playback
5	Play Video
6	Fast Forward Video Playback
7	Stop Video Recording or Playback
8	Digital Zoom

Power/Interconnect Sockets (right side)

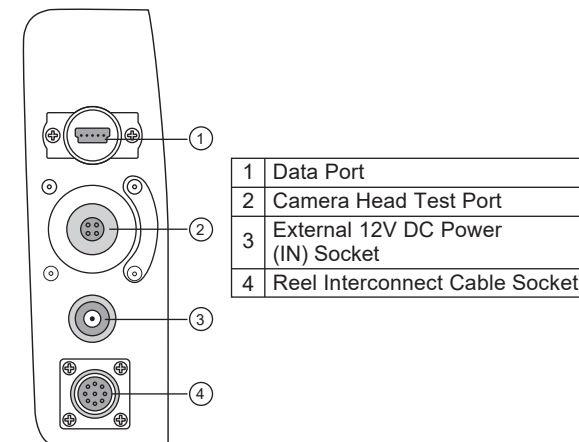

AC in Power Socket (bottom left side)

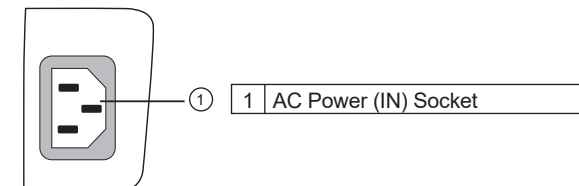

Mounting the Control Module

- Line up the control module's mounting pins(a) to the open slots on the reel mounting plate.
- Lower the control module into the reel mounting plate(b).
- Standing in front of the control module, push the bottom of the control module backward until the control module locks in place.

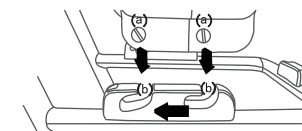

Do not use the Control Module as a handle to move the reel. Move the reel only by the reel's handle.



Using the Reels

Cage Lock - Unlock the cage lock by pulling the T-knob (B), turning it a ¼ turn and releasing so the pin falls into the keyed slot (C).

Friction Brake - Set the friction brake (A) to slow the movement of the cable rod drum.

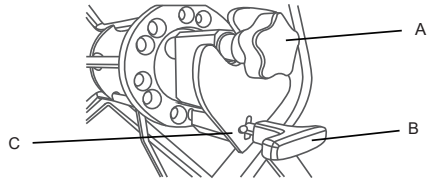

Cable Guide - Turn the reel so that the pushrod goes through the cable guide.





Keyboard Function Keys

Keys	Function	Description
ESC	Menu step back and clear text	Returns to the previous screen or clears text from the screen
F1 Help	Help	Control Module help and information screens
F2 Info	On-screen Distance, Date and Time	Toggles information position on the screen. Bottom, Top, Off
Ctrl + F2	Information Color	Changes the text color of the on-screen Distance
Ctrl + F3	Text Writer On/Off	Turns the text writer on & off
F3	Text Color	Changes the text font color
F4	Background Color	Changes the color
F5	Recall Page	Recalls saved pages
F6	Save Page	Save current page to memory
F7	Delete Page	Delete the current page
F8	Delete All Pages	Delete all saved pages
F9	Display Setting	Adjust LCD settings
F10	Menu	Access File and Setup Menus
F11	Font	Changes the font size
F12	WiFi On/Off	Turns WiFi on and off

Basic Functions

Video Recording:

1. Press  to start recording.
2. Press  to stop recording and return to live camera.

Snapshot Recording:

1. Press the  camera key to take snapshots when viewing or recording from the camera or during video playback.

Zooming:

1. Press  to activate zoom window.
2. Use the arrow keys to select an area to zoom, then press enter.
3. Repeat these steps to use three levels of zoom.

vCam-6 Menu Navigation

Use the F10 Menu key to open the "File Menu." Use the **Left/Right arrow** keys to move through the various menu sections.

To select multiple files to copy, move or delete, highlight the file and press the Enter Key to check multiple files. Press the TAB key to select the full page of videos or pictures.

Video Playback and Viewing Snapshots

Press the **Menu key** to bring up the File Menu.

Use up/down keys to select All Files, Videos or Pictures, right arrow to video or picture file list, use down arrow to highlight video to play or picture to view, right arrow to Play and press Enter or use right arrow to play or view.

Copy, Move, Delete or Rename Videos and Pictures

Insert a USB stick or SD card into the media port on the left side.

Follow the above Menu Navigation instructions but for the last step, select Copy, Move, Delete, or Rename as the action.

A progress indicator will appear on the screen showing the time remaining for the file copy, move or deletion. Wait until the progress indicator goes away and the main file menu is displayed before removing the USB stick or SD card.

NOTE

Copy = Makes a copy of the video or picture on a USB stick or SD card, the original remains on the hard drive.

Move = Moves the file from the hard drive to the USB stick or SD card. No file remains on the hard drive.

Delete = Deletes the file from the hard drive.

TIPS



It is not recommended that the internal hard drive is used for long-term storage. It is good practice to do regular backups and transfer videos and pictures to an external storage device or office/home computer.

Your Local Distributor:



4310 FM 2218 Rd
Richmond, TX 77469

Corp: (281) 969-8530

info@indepthUS.com

www.indepthUS.com

Vivax-Metrotech Corporation
(World Headquarters, United States of America)
3251 Olcott Street, Santa Clara, CA 95054, USA

Tel: +1-408-734-1400

Email: SalesUSA@vxmt.com

P/N: 4.04.000088